



## 型号

**NL52-NCC-1**  
(4块叶片, 逆时针旋转)

**NL52-NCW-2**  
(4块叶片, 顺时针旋转)

净重: 6 kg (13 lbs.)

**NL52-NCC-3**  
(4块叶片, 逆时针旋转)

**NL52-NCW-4**  
(4块叶片, 顺时针旋转)

净重: 6.6 kg (14.5 lbs.)

### 特点:

- 轴心轮毂、NEMA 56C、6AM、或底座安装
- 壳体、转子和端盖都经过耐腐蚀处理
- 不需要加润滑油 — 不会污染工作场所的空气
- 任何平面安装
- 金属消音器: AC990增加5cm高度 (安装后)

• II 2 GD c T4

### 建议配项:

- 过滤器AH106F
- 调节阀AH107R
- 压力表AA806
- 维修包K833

### 可选配项:

- 底座固定 AL414 — 安装此底座固定 AL414后可把上述型号都变为底座安装的固定方法, 另安装后会气动马达的高度约增加5cm。



• 图示为轴心轮毂的型号与可另外选购的底座固定。

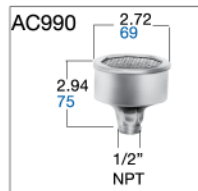

## 轴心轮毂安装 (NL52-NCC-1, NL52-NCW-2)

英寸 / mm

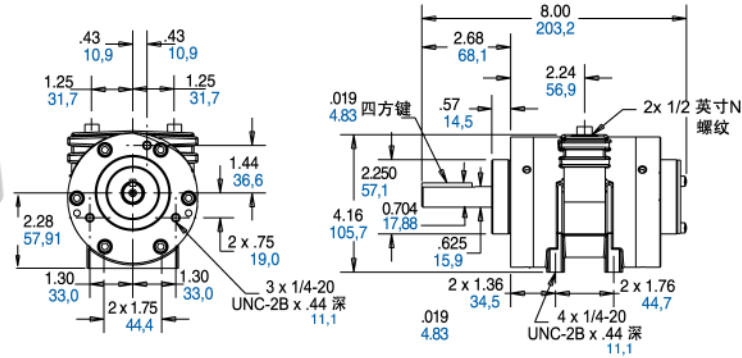

## 美标 NEMA 56C - (NL52-NCC-3, NL52-NCW-4)

英寸 / mm

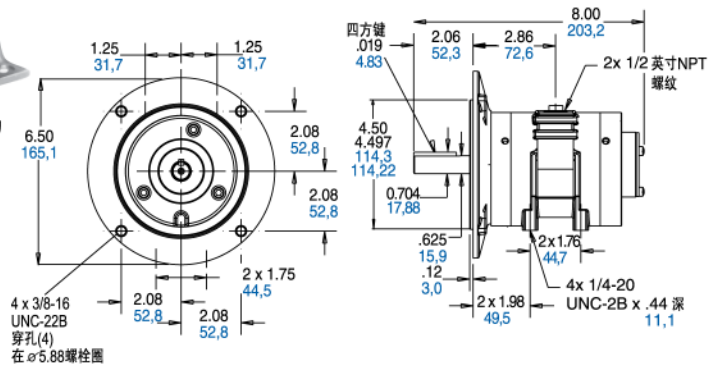

## 6AM 轴心轮毂安装 - (NL52-NCC-5, NL52-NCW-6)

安装尺寸与 6AM-NRV-7A 相同

英寸 / mm

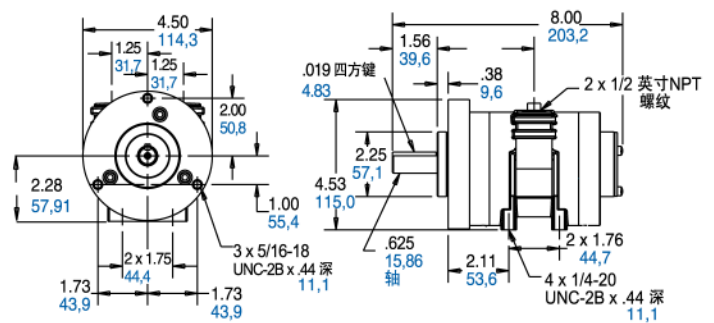

## 耗气量 vs. 转速

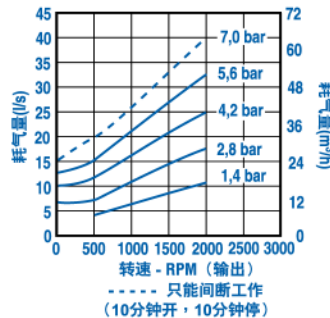
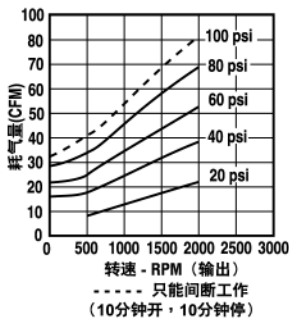

## 扭矩 vs. 转速

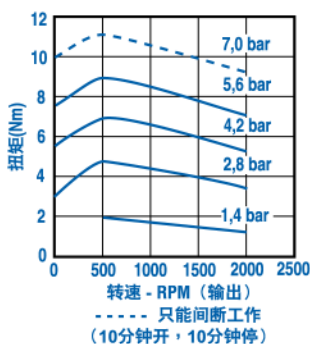
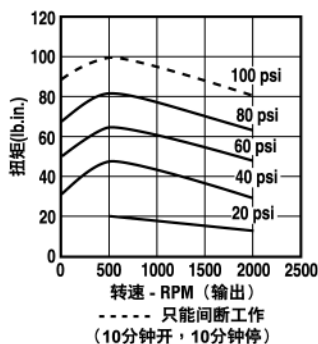

## 输出功率 vs. 转速

